

# HI-FI AUDIO & ROOM ACOUSTICS PREMIUM SEATS

## SECTIONAL SOFA LOUNGE COLLECTION

Made of Genuine Ox Leather and the latest Silicone Leather Technology

Heavy Duty Electric Motor with 2 years warranty

with Chilled Cup Holder, USB Charger and Ambient Light under the seats



Hi-Fi  
AUDIO  
& room acoustics  
☆☆☆☆☆

*Quality, Comfort, Style and Durability at the right price.*



MAIN BRANCH: (046) 230-4398 / 0917 856 0880  
QC DEMO BRANCH: 0917 328 0678 / 0994 484 0633

KM 21 AGUINALDO HIGHWAY, #13 BRGY. ANABU 1-B, IMUS CITY, CAVITE



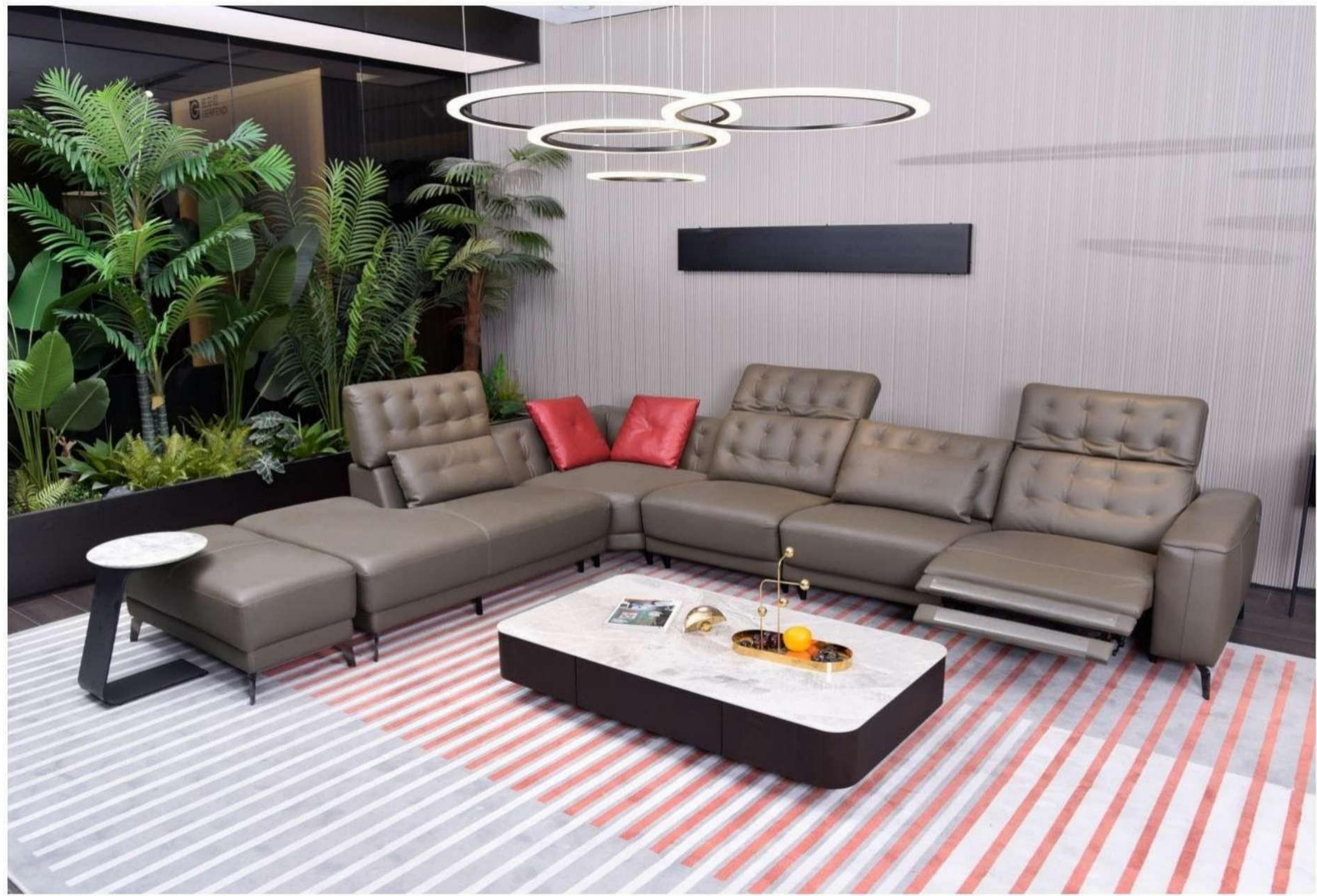

BY SIMPLE AND  
NATURAL DESIGN

**K195**

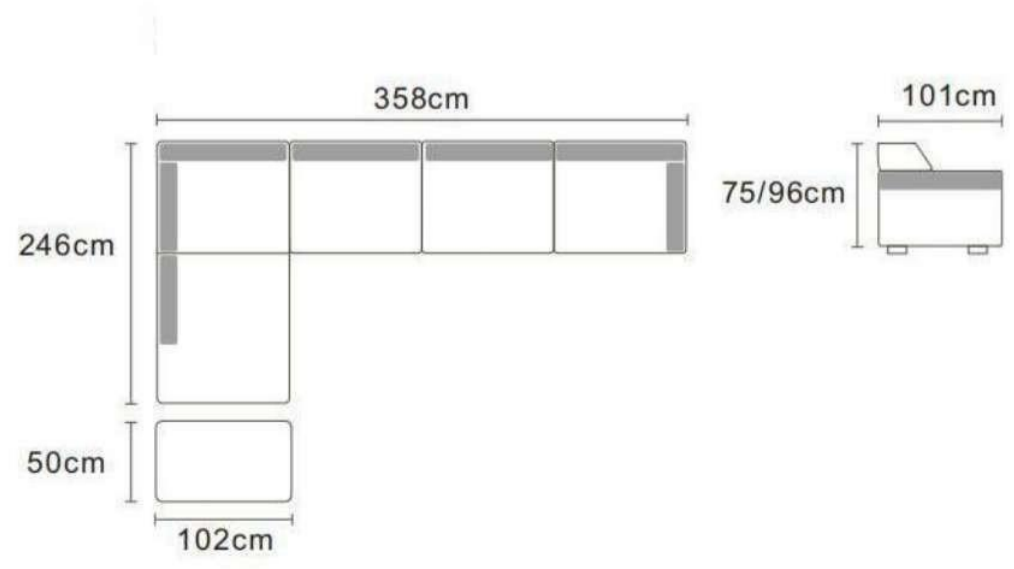



# K257

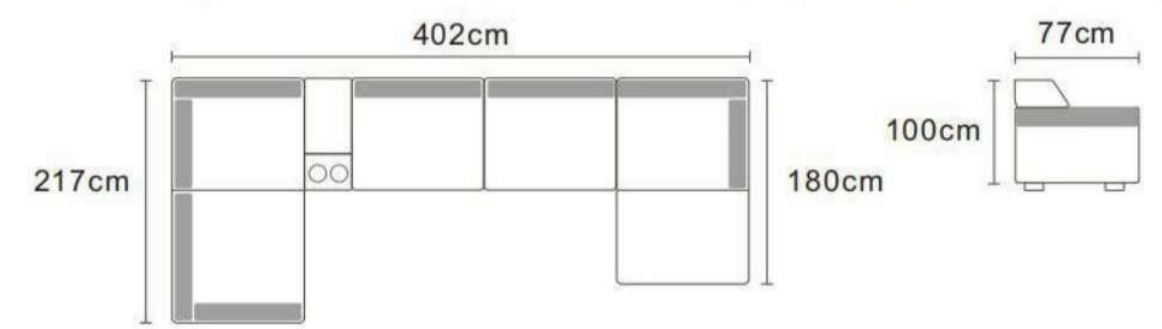

## Warm and comfortable sofa

Quality is endless repeated running in, It's art and won't make do with it, Feel the original quiet artistic conception.



**115° RECLINING BACKREST**  
AN ANGLE FOR HALF LYING

Use an Angle that better fits the curve of your waist and back  
Let the back half lie in a more relaxed position



# K257

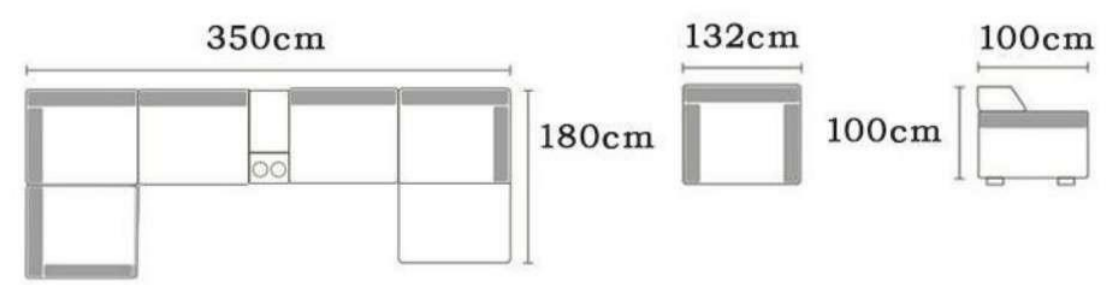

Simplicity and light  
taste in life create our own  
free fashionhome



# K198-A

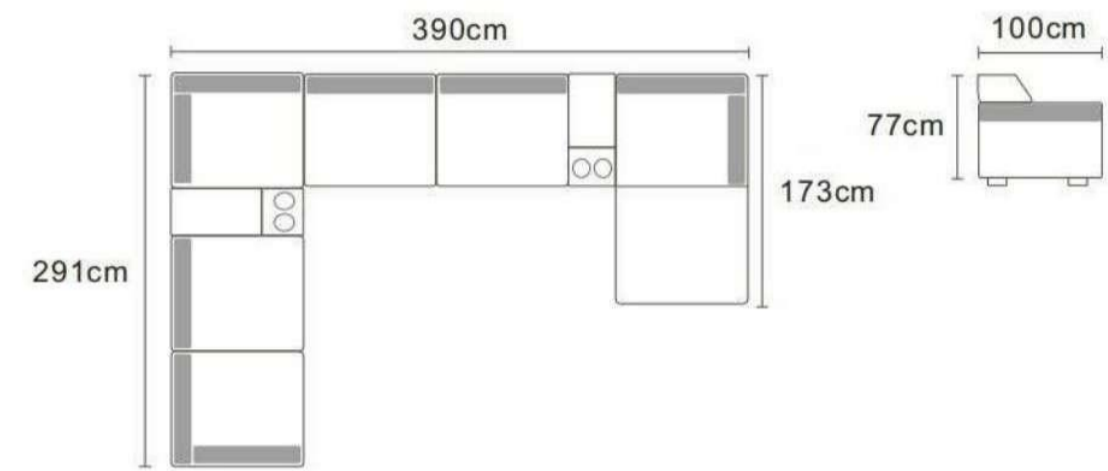

Design is but an industry fo common people. > \_\_\_\_\_



# K198-A

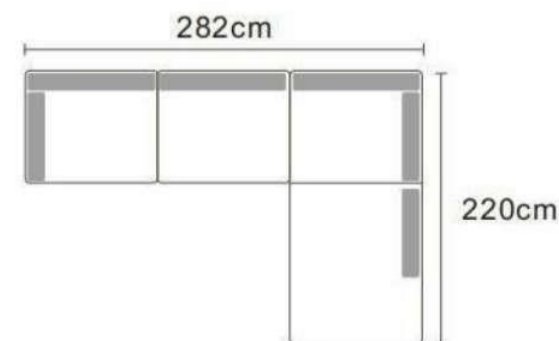

The oolot od cleqat and smpie and sinpieand simple and  
te line dongn of liwoly andamocoriic s nnure ad how  
ieng appedgive you a oamtartatle boedow ot hame



# Classics fashion



Our products are the perfect combination of artistic design, sophisticated technologies and the artistic enchantment that keep up with today's environment. So every product is popular with you.



## K262

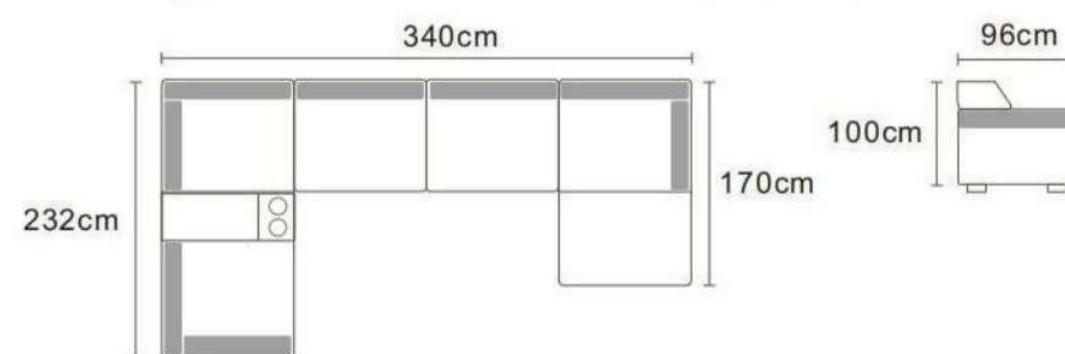



# K262

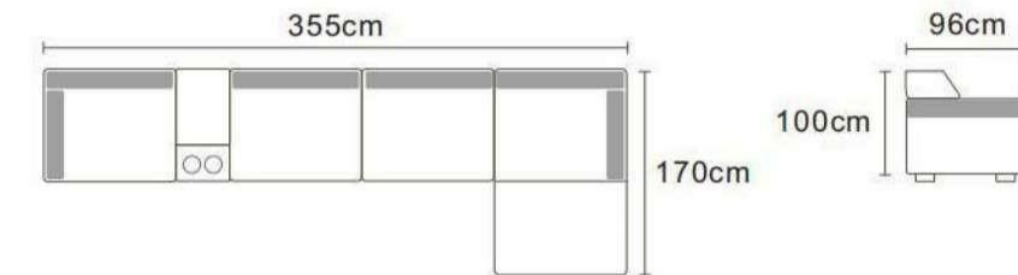

# K262

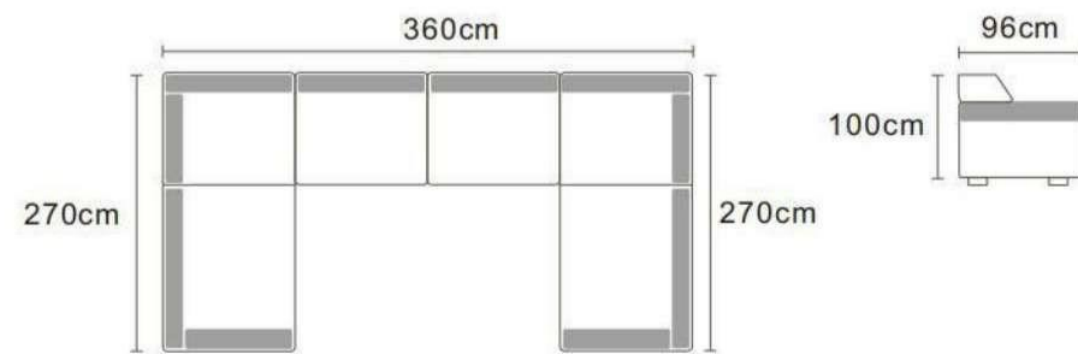



Comfortable  
life.

K128-A

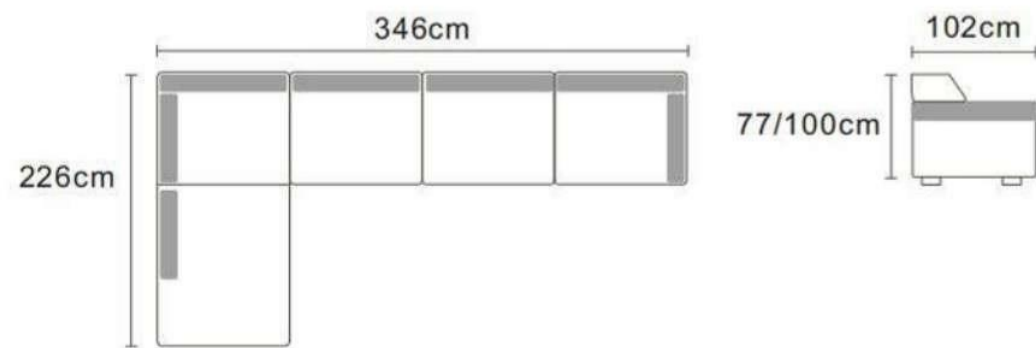



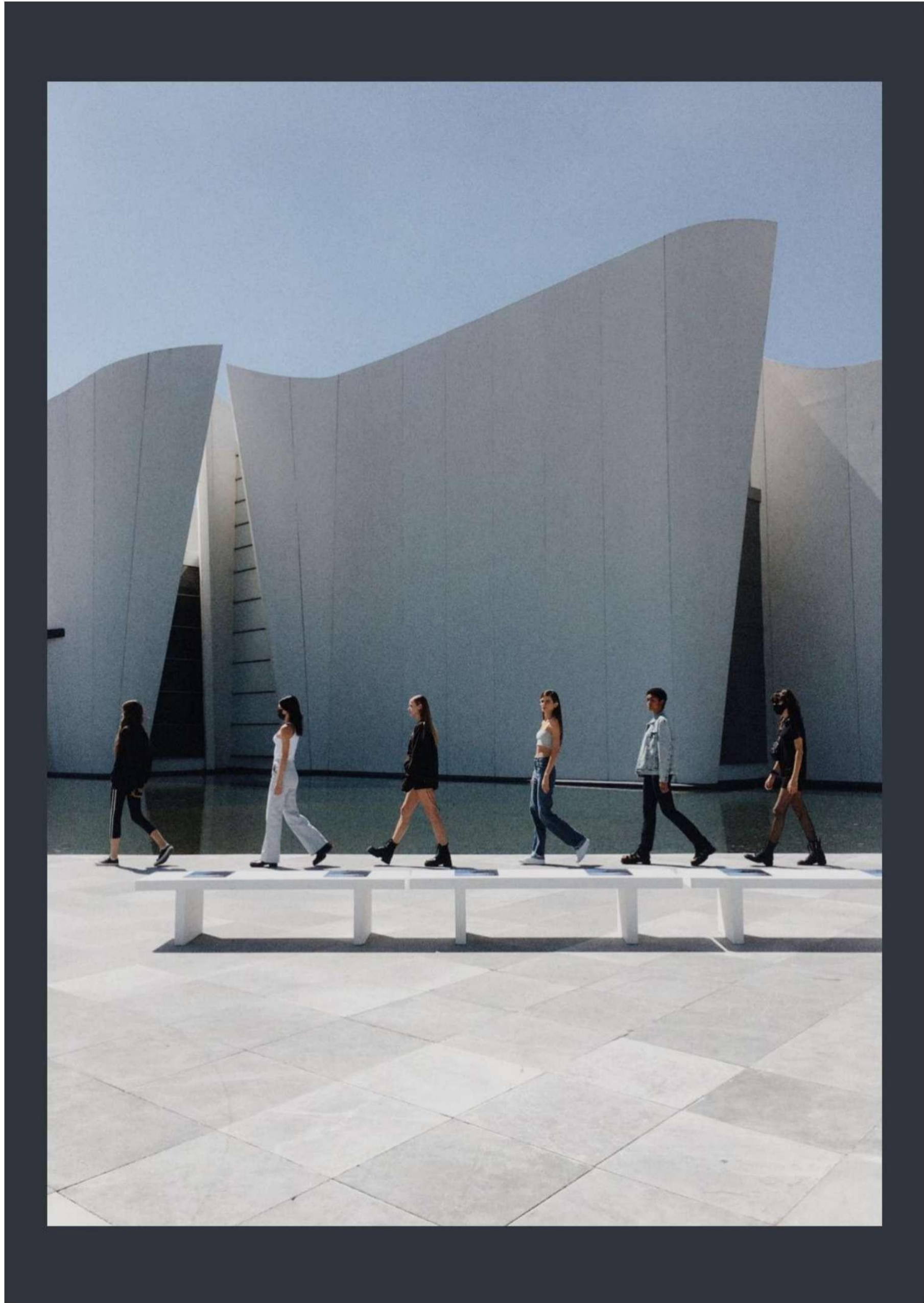

# K257

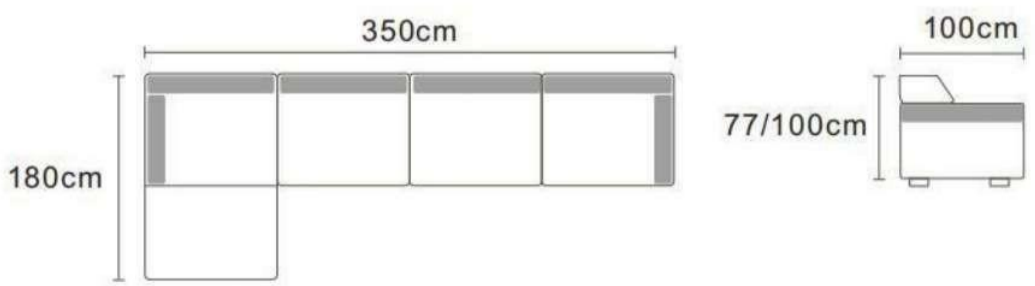

# COMFORTABLE



## K165-B

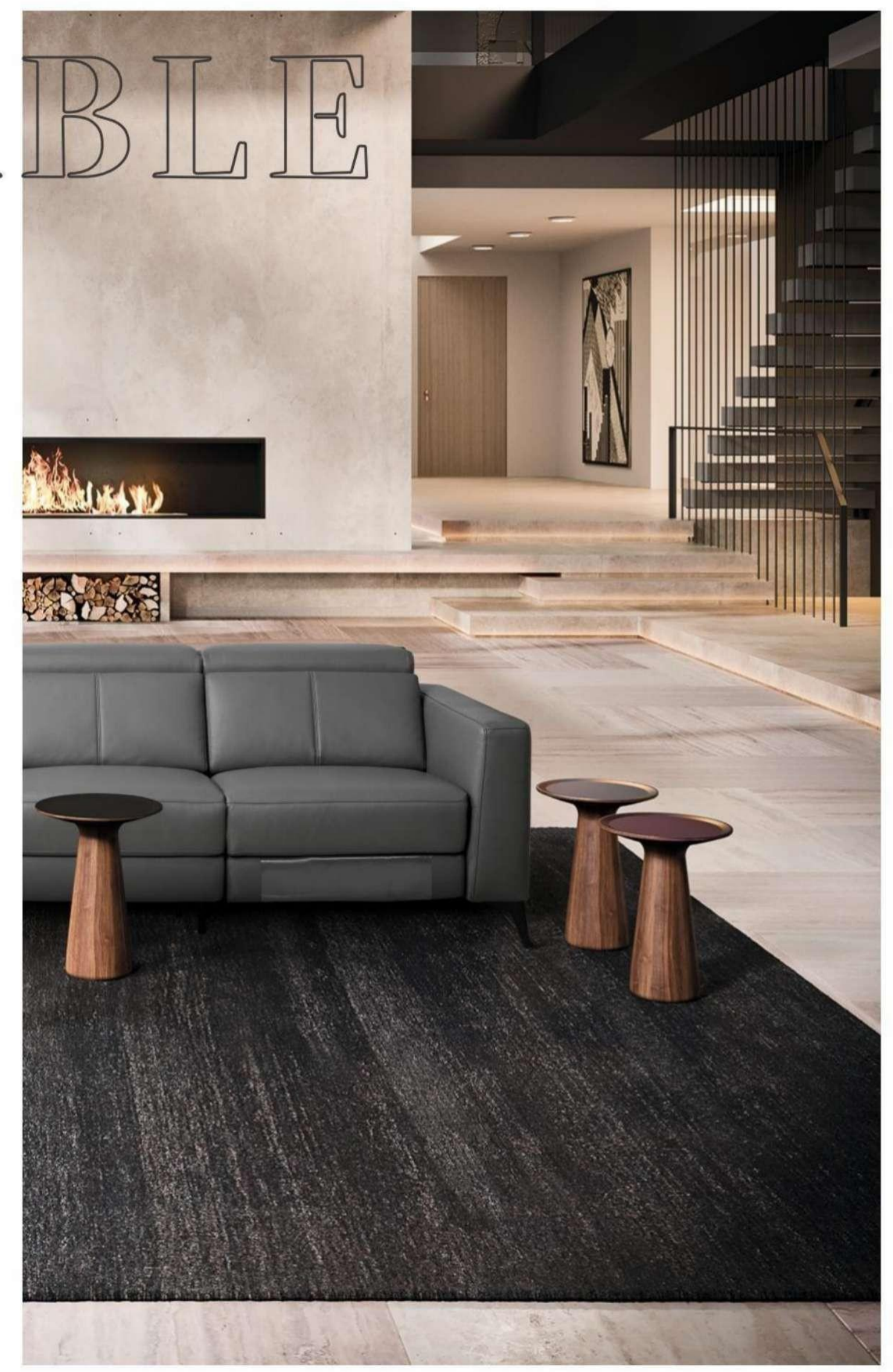
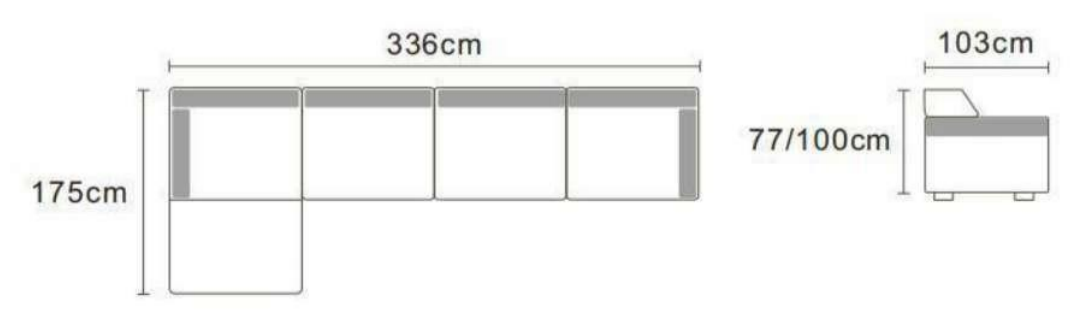



# K117-B

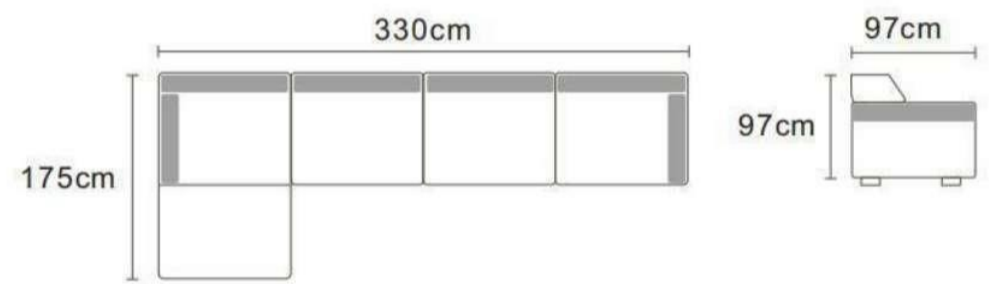

# K200-A

规格: 左1D+1+1+面右妃

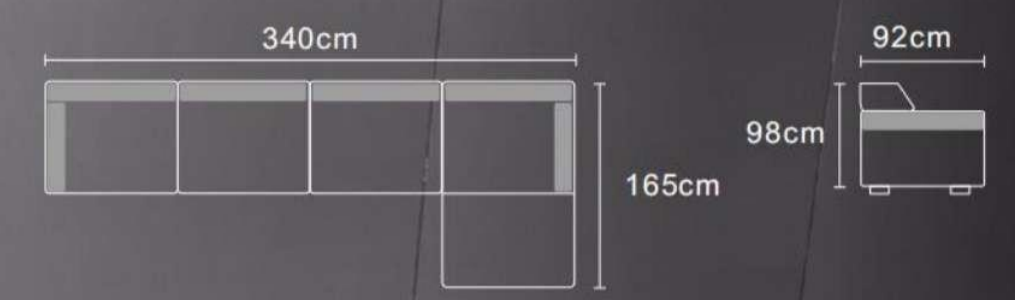

MAIN BRANCH: (046) 230-4398 / 0917 856 0880  
QC DEMO BRANCH: 0917 328 0678 / 0994 484 0633

KM 21 AGUINALDO HIGHWAY, #13 BRGY. ANABU 1-B, IMUS CITY, CAVITE





# K253

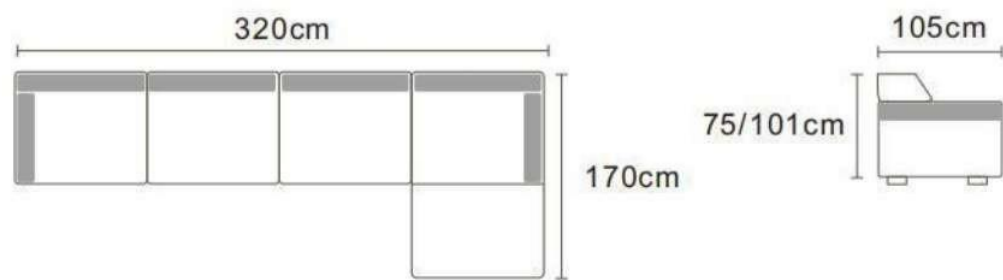

# K198-A

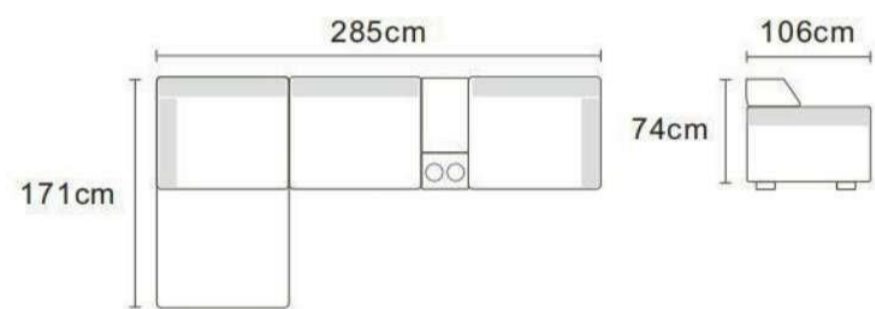

MODERN DESIGN STYLE  
WITH CONCISE AND



## Fashion

Simple charm, environmental  
proocton materal

MAIN BRANCH: (046) 230-4398 / 0917 856 0880  
QC DEMO BRANCH: 0917 328 0678 / 0994 484 0633

KM 21 AGUINALDO HIGHWAY, #13 BRGY. ANABU 1-B, IMUS CITY, CAVITE





# ENJOY LIFE

*AND LIFE TO  
ENJOY*

## K226-A

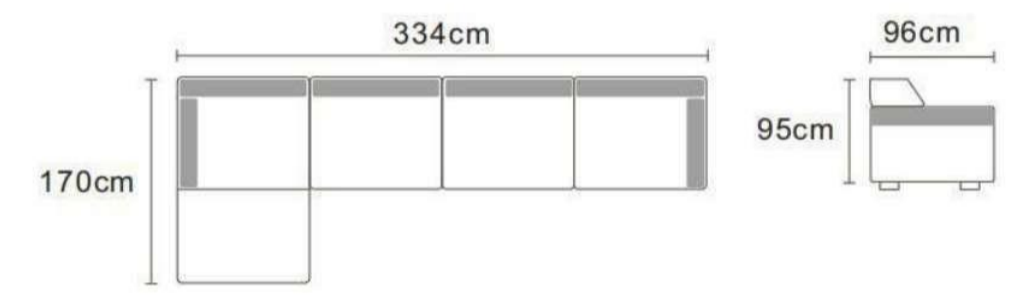

# MERIDIANI FURNITURE

## L01-A

